

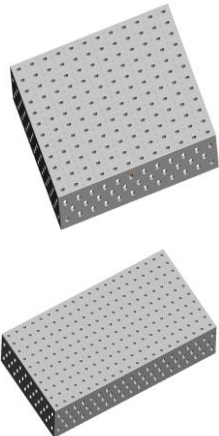

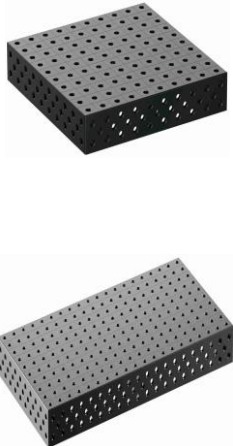











Price List of D16 series 3D Welding Table

1、Welding Table

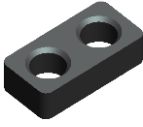
No.	Goods Description	Pictures	Size(mm)	Model	Unit Price (USD)
1	3D Casting Welding Table without legs (The legs are optional) (D16 Series)		1000x1000x100	CWD161010	\$835.00
			1200x800x100	CWD161280	\$1,060.00
			1200x1200x100	CWD161212	\$1,300.00
			1500x1000x100	CWD161510	\$1,300.00
			1500x1500x100	CWD161515	\$1,680.00
			2000x1000x100	CWD162010	\$1,680.00
			2400x1200x100	CWD162412	\$2,235.00
2	3D Casting Welding Table without legs (The legs are optional), Nitrided (D16 Series)		1000x1000x100	CWD161010N	\$1,050.00
			1200x800x100	CWD161280N	\$1,165.00
			1200x1200x100	CWD161212N	\$1,390.00
			1500x1000x100	CWD161510N	\$1,390.00
			1500x1500x100	CWD161515N	\$2,020.00
			2000x1000x100	CWD162010N	\$2,000.00
			2400x1200x100	CWD162412N	\$2,650.00



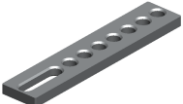
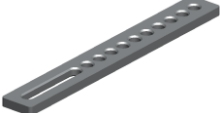
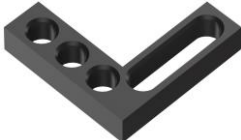



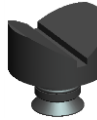

2、Table Leg

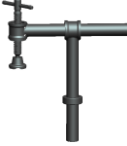

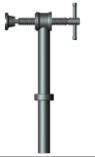



No.	Goods Description	Pictures	Size(mm)	Model	Unit Price (USD)
1	Fixed Leg		φ89×200	TL16200	\$15.00
			φ89×350	TL16350	\$16.00
			φ89×450	TL16450	\$17.00
			φ89×620	TL16620	\$19.00
	Universal wheel Leg		φ89×200	TL16200W	\$26.00
			φ89×350	TL16350W	\$27.00
			φ89×450	TL16450W	\$28.00
			φ89×620	TL16620W	\$30.00

No.	Goods Description	Pictures	Size(mm)	Model	Unit Price (USD)
1	Clamping and Locating Angle Bores		90x25x90 Bore/Bore	LAB1690901	
			90x25x90 Oblong/Oblong	LAB1690902	
			90x25x90 Bore/Oblong	LAB1690903	
			90x37.5x25	LAB169025	
			50x25x40	LAB165040	
			140x25x90	LAB1614090	
2	Universal-stop		55x25x12	US1655	
			90x25x12	US1690	
			110x25x12	US16110	
			140x25x12	US16140	
			190x25x12	US16190	
			250x50x12	US16250	
			400x50x12	US16400	
3	Flat Angle Bracket		90x90x12	FAB169090	
			275x200x12	FAB16275200	

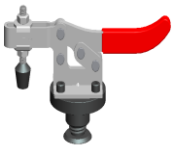
4	V-block Locations		φ48x90°	VBL4890	
			φ68x120°	VBL68120	

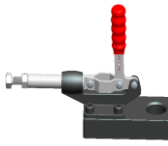
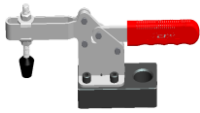

5、Clamping and Fixing Tools

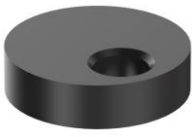
No.	Goods Description	Pictures	Size(mm)	Model	Unit Price (USD)
1	180° Screw Type Clamping with Steel Handle		200x200	SC163001	
2	180° Screw Type Clamping with Swivel Handel		200x200	SC163002	
3	90° Screw Type Clamping with Steel Handle		200x150	SC163003	
4	90° Screw Type Clamping with Swivel Handel		200x150	SC163004	
5	45° Screw Type Clamping with Steel Handle		200x200	SC163005	
6	45° Screw Type Clamping with Swivel Handle		200x200	SC163006	
7	Compensating Screw Type Clamping with Steel Handle		200x150	CSC163001	
			200x200	CSC163002	
8	Compensating Screw Type Clamping with Swivel Handle		200x150	CSC163003	
			200x200	CSC163004	
9	Vertical Toggle Clamp with Round Block		φ58x20x16	TC2001001	
10	Push Pull Toggle Clamp with Round Block		φ68x20x16	TC2001501	









11	Horizontal Toggle Clamp with Round Block		φ68x20x16	TC2001502	
12	Vertical Toggle Clamp with Square Block		130x65x12	TC2001002	
13	Push Pull Toggle Clamp with Square Block		130x65x12	TC2001003	
14	Horizontal Toggle Clamp with Square Block		130x50x12	TC2001503	
15	90° Angle Bushing		φ16x90°	CS161	
16	45° Angle Bushing		φ16x45°	CS162	
17	Horizontal Angle Bushing		φ16x180°	CS163	
18	Vertical Angle Bushing		φ16x90°	CS164	
19	Eccentric Locating Disc		φ60x16mm(Height)	ETL10025	

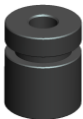

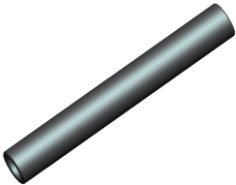
6、Locking Tools

No.	Goods Description	Pictures	Size(mm)	Model	Unit Price (USD)
1	Rapid Locking Bolt		Φ16 x 24mm	RLP1624	
			Φ16 x 36mm	RLP1636	
2	Countersunk Head Locking Bolt		Φ16 x 24mm	CHLP1624	
			Φ16 x 36mm	CHLP1636	

3	Countersunk Head Fast Locking Bolt		Φ16 x 24mm	CHFLP1624	
			Φ16 x 36mm	CHFLP1636	
4	Magnetic Locking Bolt		Φ16 x 12mm	MLB1612	

7、Auxiliary Tools

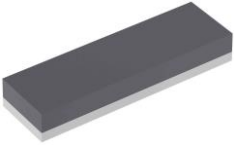
No.	Goods Description	Pictures	Size(mm)	Model	Unit Price (USD)
1	Adjustable Spacer		φ80x100	AS1695	
2	Lifting Ring		2T	LR162	
3	Clamping Sleeve		φ16x300	CS28300	
			φ16x600	CS28600	
4	Accessory Cart		1000x600x1025	AC161000600	
5	Ground Connector		120x35	GC16	
6	Spacer Set		0.5, 1, 2, 2.5, 3, 4, 5, 10, 20, 50	S160520	
7	Burner Holder		200mm	BH28200	
8	14# Hexagon Allen Wrench		150	HAW16	
9	Round Brush		φ18x80	NB16	

10	Bench Stone		200x30	OS16	
11	Spray Bottle		100x200	SB16	